



ALLIED MAKER

MADE IN NEW YORK

Trimless Flush Mounting Kit

Multi-Surface
Installation Guide

212-334-7333

help@alliedmaker.com

LIVING FINISHES

Wear Gloves!



THIS PRODUCT MUST BE INSTALLED IN ACCORDANCE WITH THE APPLICABLE
INSTALLATION CODE BY A PERSON FAMILIAR WITH THE CONSTRUCTION AND
OPERATION OF THE PRODUCT AND HAZARDS INVOLVED

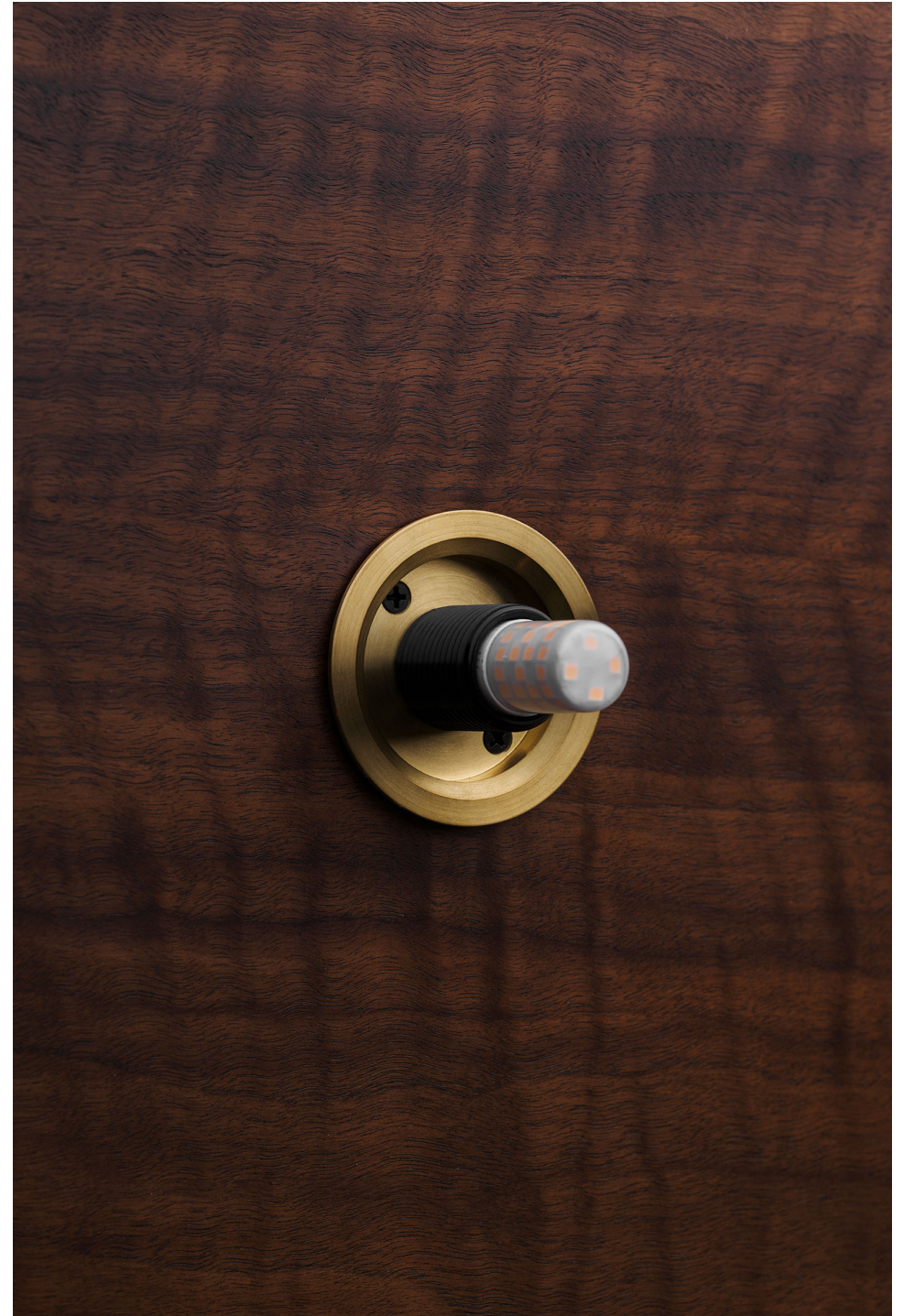

Contents Included

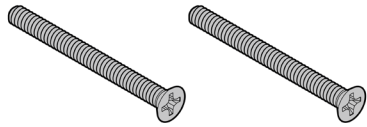

2x 6-32 x 1-½" Screw

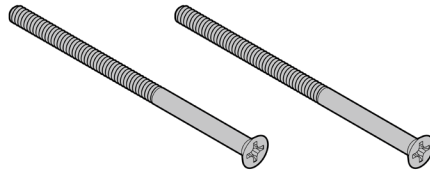

2x 6-32 x 2-½" Screw

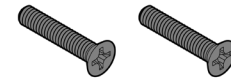

2x 8-32 Screw

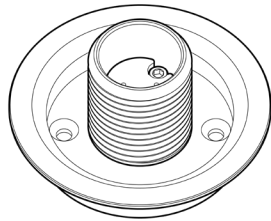

Lighting Fixture

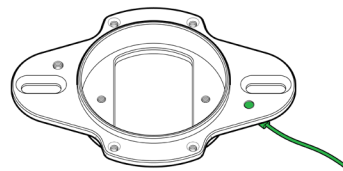

Mounting Plate

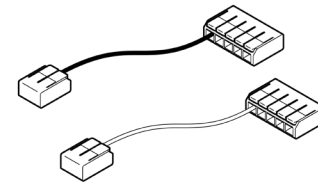

2x Wago Clip Wire Lead

2

Using the provided 8-32 screws **1**
mount the mounting plate **2**
onto the junction box **3**

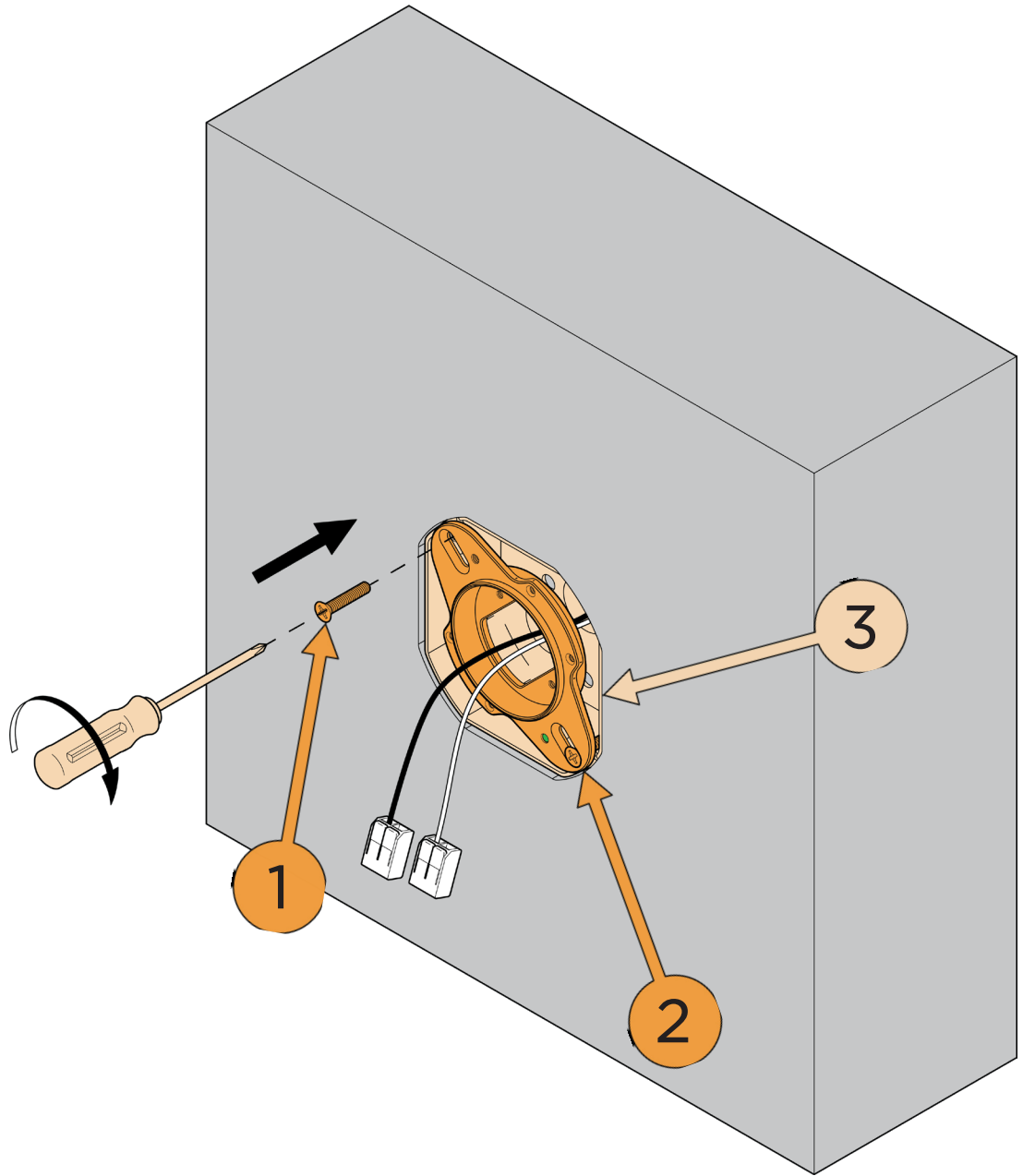

3

Travel the two port wago clip ① wire leads through the centerhole of the additional surface ② (wood panel, mirror, tile, substrate, etc.)

Install the additional surface ②

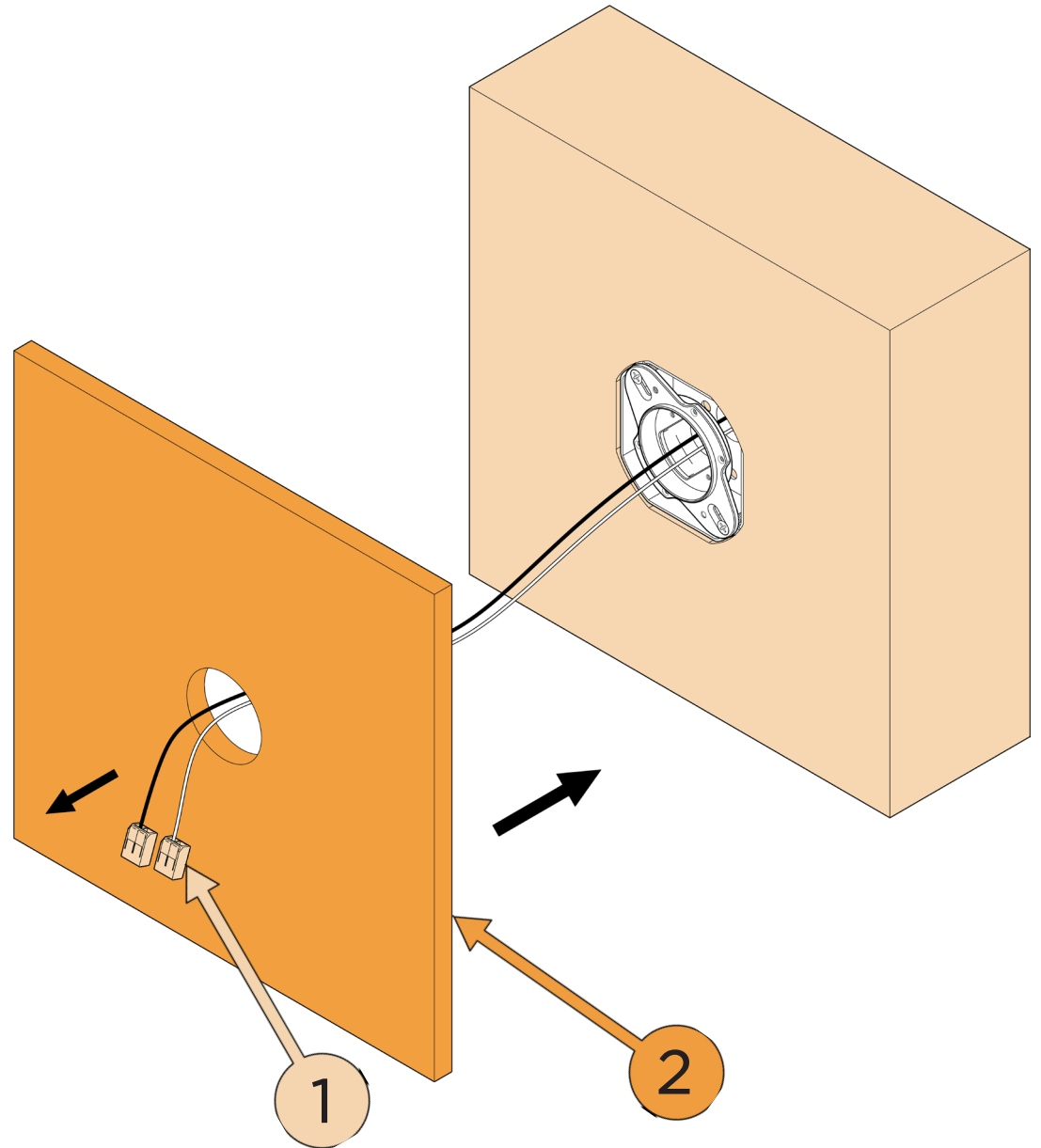
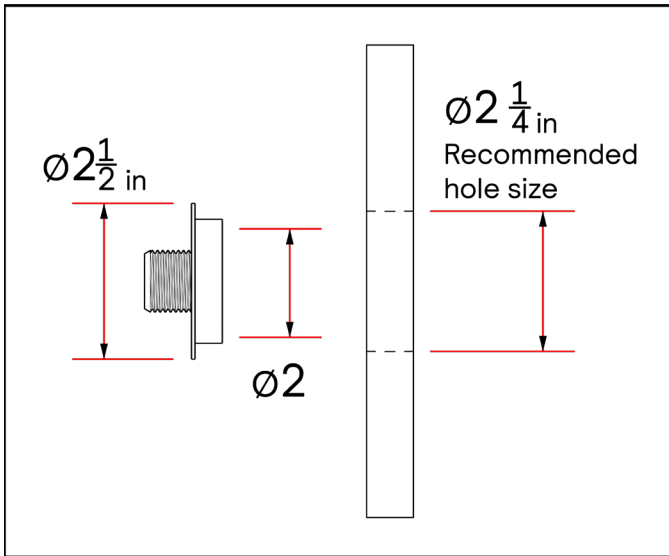

4

Connect the wires from the lighting fixture ① to the two port wago clip ② wire leads.

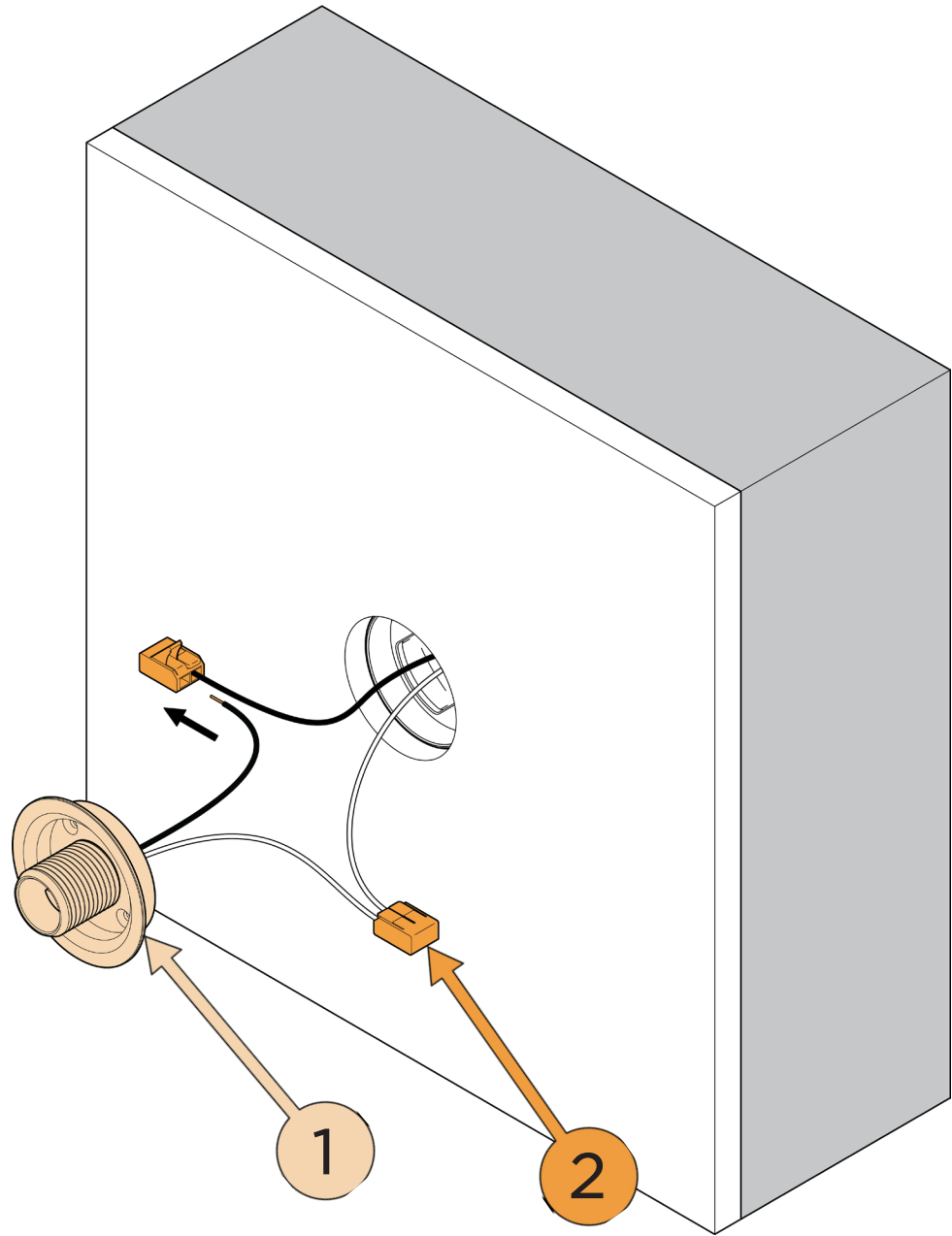

5

Using the provided 6-32 screws **1**
mount the lighting fixture **2**
onto the mounting plate **3**

*Measure the distance between the finished surface and the junction box to determine which 6-32 screw length to use.

*Do not overtighten the 6-32 screws.
Overtightening can lead to potential damage to the wall.

