



Tri Cone Mini

INSTALLATION GUIDE



HANDMADE
IN U.S.A.



WEAR GLOVES
DURING INSTALL

FRAGILE FINISHES

DANGER: ELECTRIC SHOCK RISK. TURN OFF ELECTRICAL POWER BEFORE BEGINNING INSTALLATION AND USE CAUTION WHEN INSTALLING.



+1 212 334 7333

www.alliedmaker.com • sales@alliedmaker.com



1

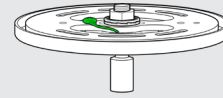

Canopy Assembly



2x Machine Screws



Inspect Contents

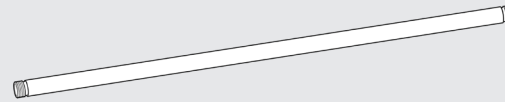

Hang Rod



Suction Cup

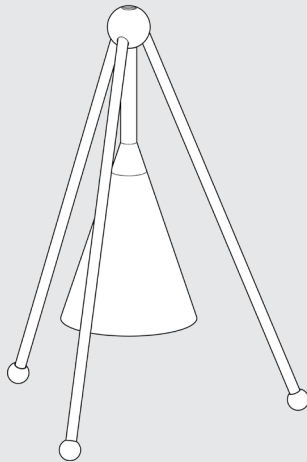

Fixture

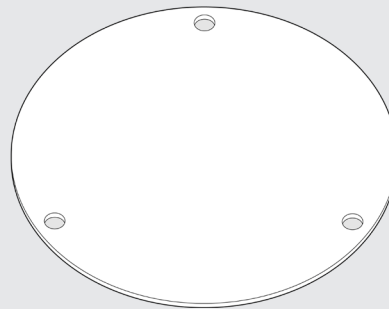

Glass Shade

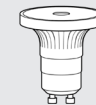

Light Bulb

2



Fixture Body

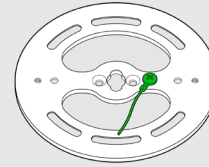

Universal Backplate



Fixture Socket



Terminology



3x Fixture Arm

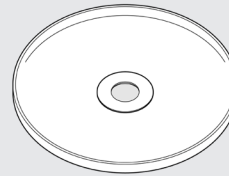

Canopy

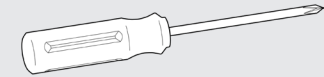

Phillips Screwdriver
(Not Included)



3x Ball Stop



Hang Straight
&
Knurled Ring

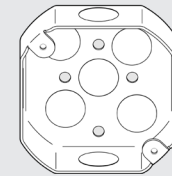

Junction Box
(Not Included)

3

—
Preparation

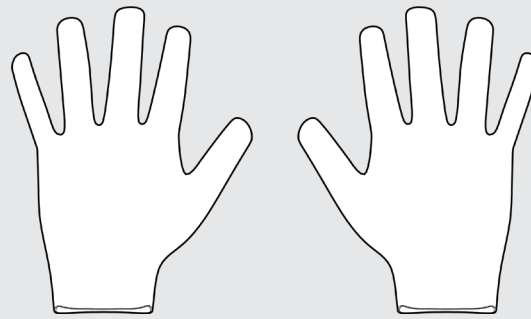

Nitrile Gloves

4

Travel the wires from the fixture through the hang rod. Then, screw the hang rod onto the fixture body to secure the hang rod into place.

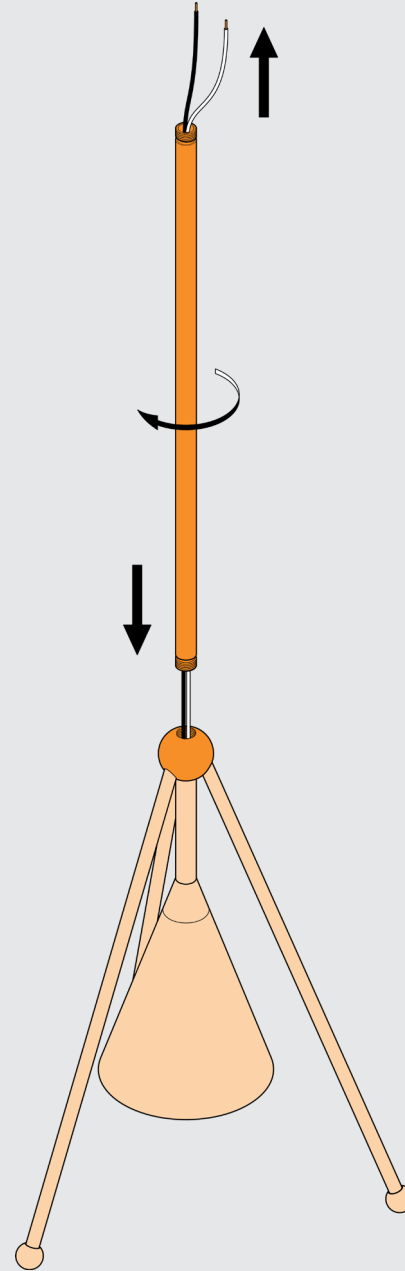

5

Travel the wires from the fixture through the hang straight on the canopy assembly. Then, screw the hang straight onto the hang rod.

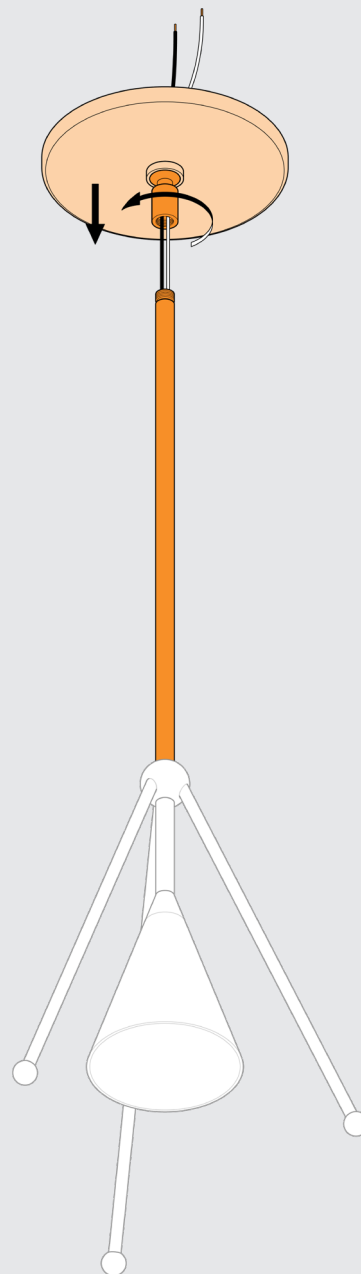

6

Unscrew the knurled ring from the
hang straight and then carry the
canopy and knurled ring down.

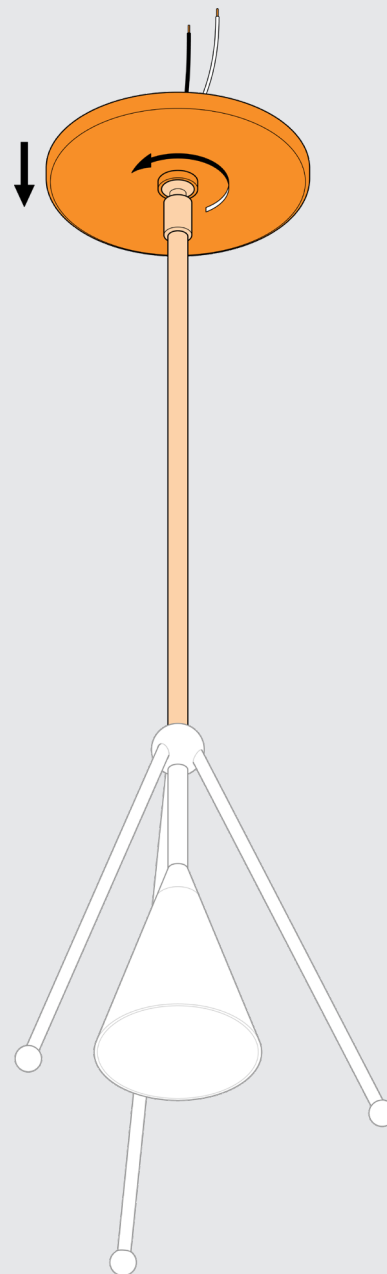

7

Mount the universal backplate onto the junction box using the provided machine screws.

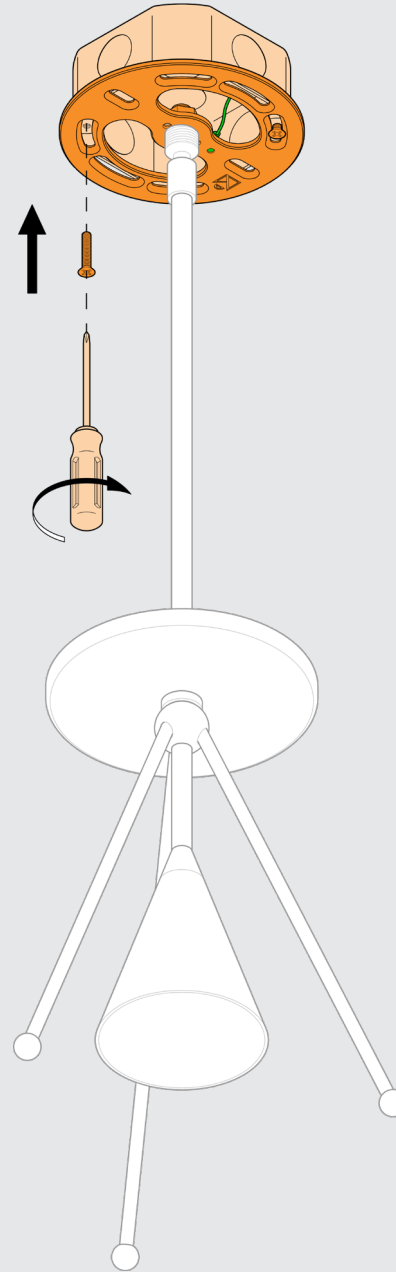

8

Connect the ground wire from the universal backplate with the ground wire from the junction box using a wire nut. Then, connect the wires from the fixture to the wires from the junction box using wire nuts.

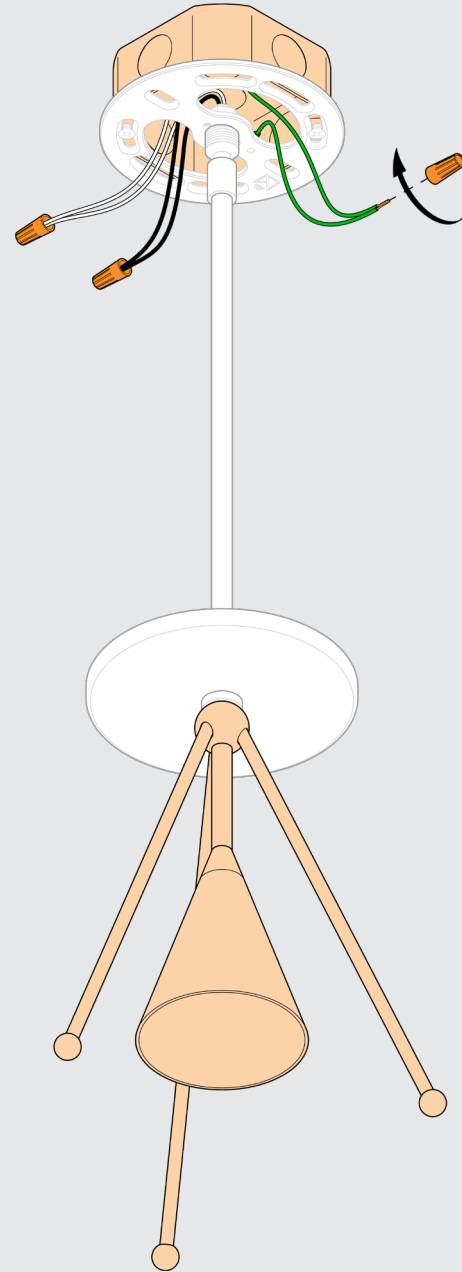

9

Carry the canopy back up and over the hang straight and hold in place. Then, carry the knurled ring back up and screw onto the hang straight to secure the canopy into place.

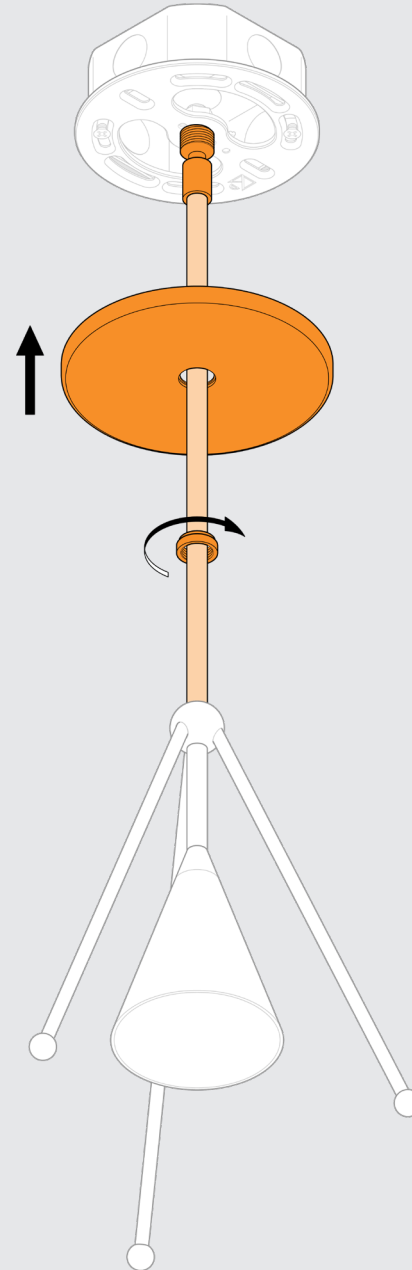

10

Apply the suction cup to the light bulb. Insert the light bulb into the fixture socket. Then, remove the suction cup from the light bulb.

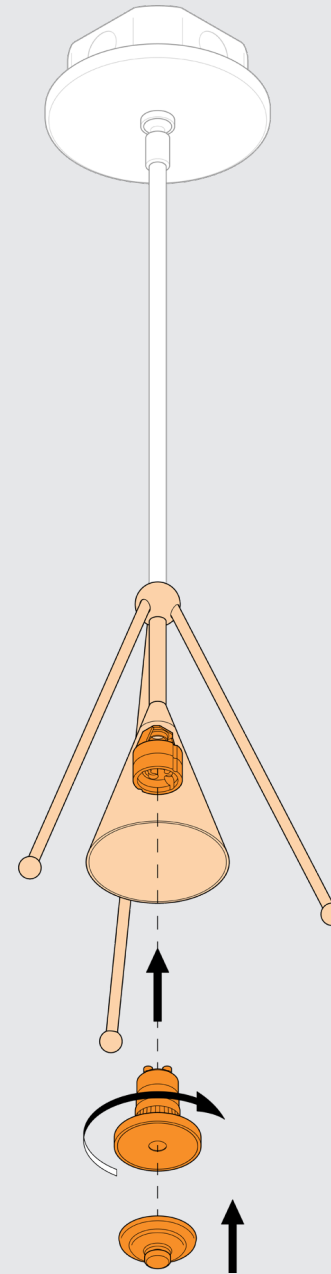

11

—
Unscrew and remove
the three ball stops
from the fixture arms.

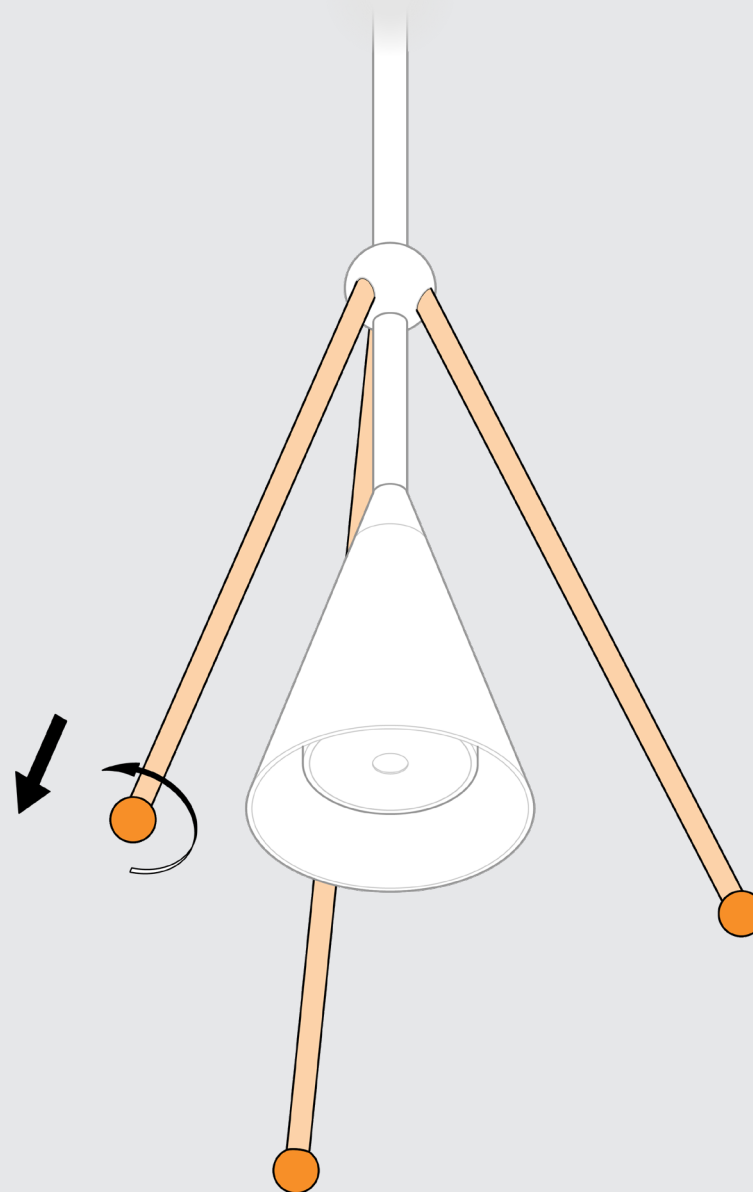

12

Carry the glass shade up to the fixture arms and insert the fixture arms through the holes on the glass shade and hold in place. Then, screw the three ball stops back onto the fixture arms to secure the glass shade into place.

