



Groove Sconce

INSTALLATION GUIDE



HANDMADE
IN U.S.A.



WEAR GLOVES
DURING INSTALL

FRAGILE FINISHES

DANGER: ELECTRIC SHOCK RISK. TURN OFF ELECTRICAL POWER BEFORE BEGINNING INSTALLATION AND USE CAUTION WHEN INSTALLING.



+1 212 334 7333

www.alliedmaker.com • sales@alliedmaker.com



1



Inspect Contents

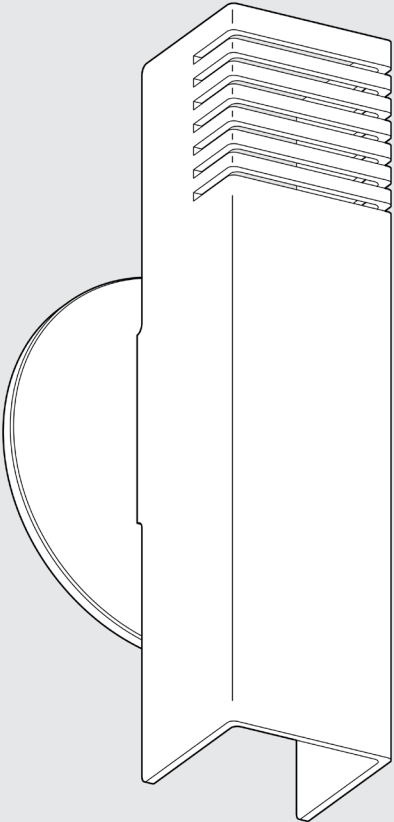

Fixture

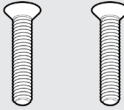

2x Machine Screw



Light Bulb

—
Terminology



Fixture Shade

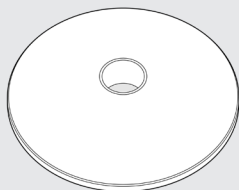

Wood Doughnut

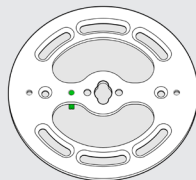

Backplate



2x Set Screw



Shade Adapter



Fixture Socket
&
Socket Cover



Hex Screwdriver

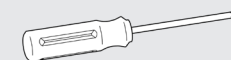

Phillips Screwdriver
(Not Included)

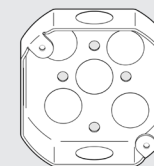

Junction Box
(Not Included)

3

Using a hex screwdriver, loosen the two set screws on the shade adapter. Then, remove the fixture shade from the fixture assembly.

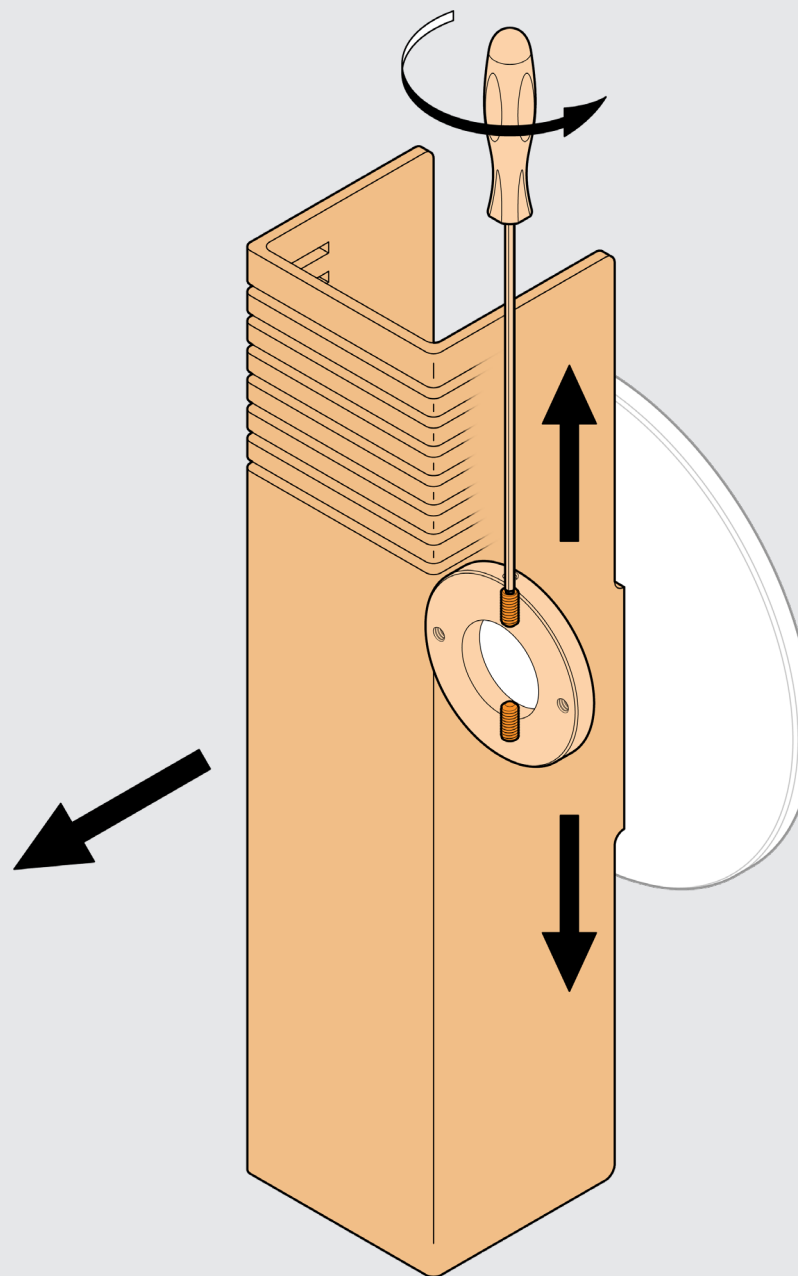

4

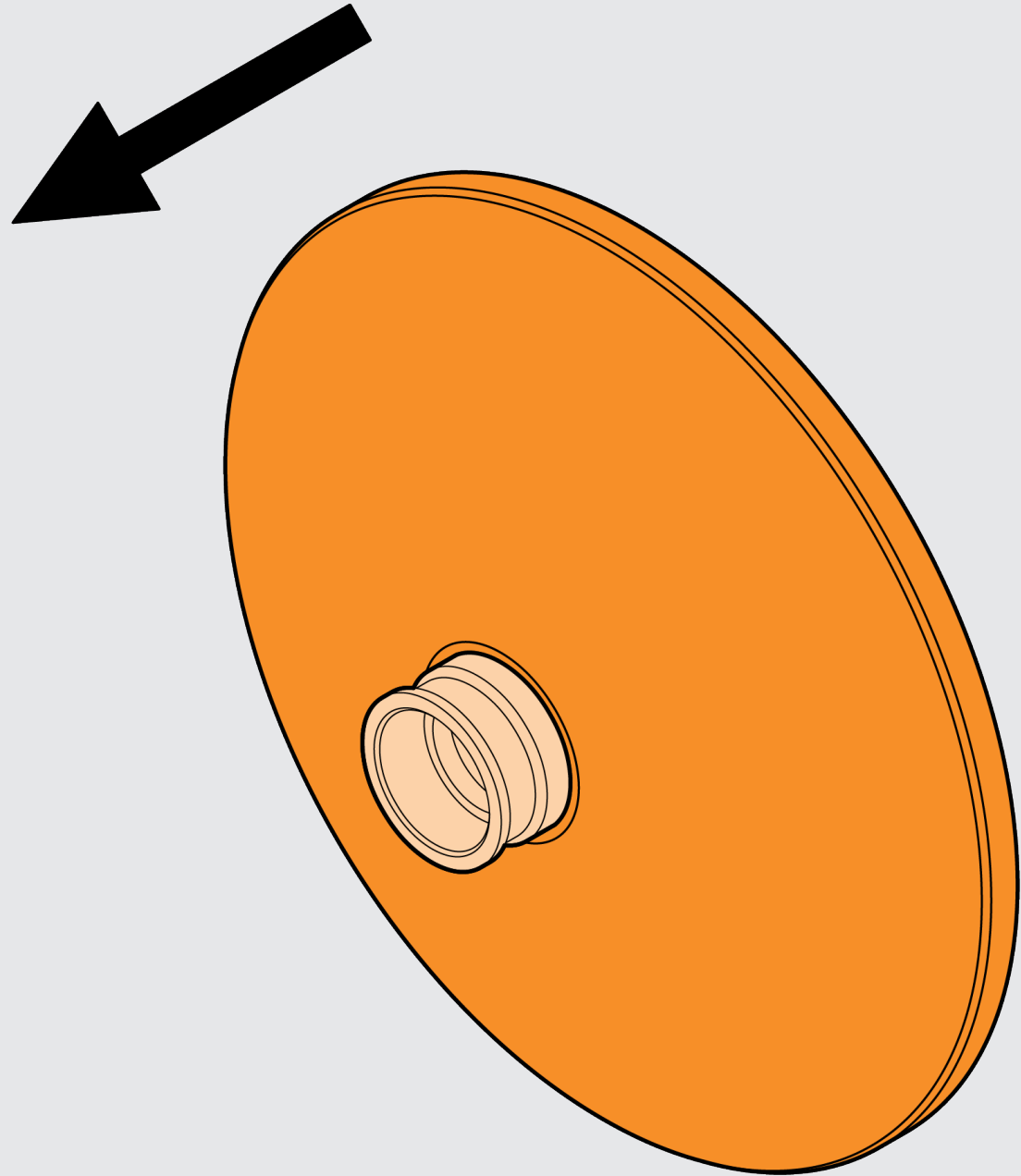

Remove the wood doughnut from the fixture backplate. The wood doughnut is magnetically attached.

5

Mount the fixture backplate onto the junction box using the provided machine screws.

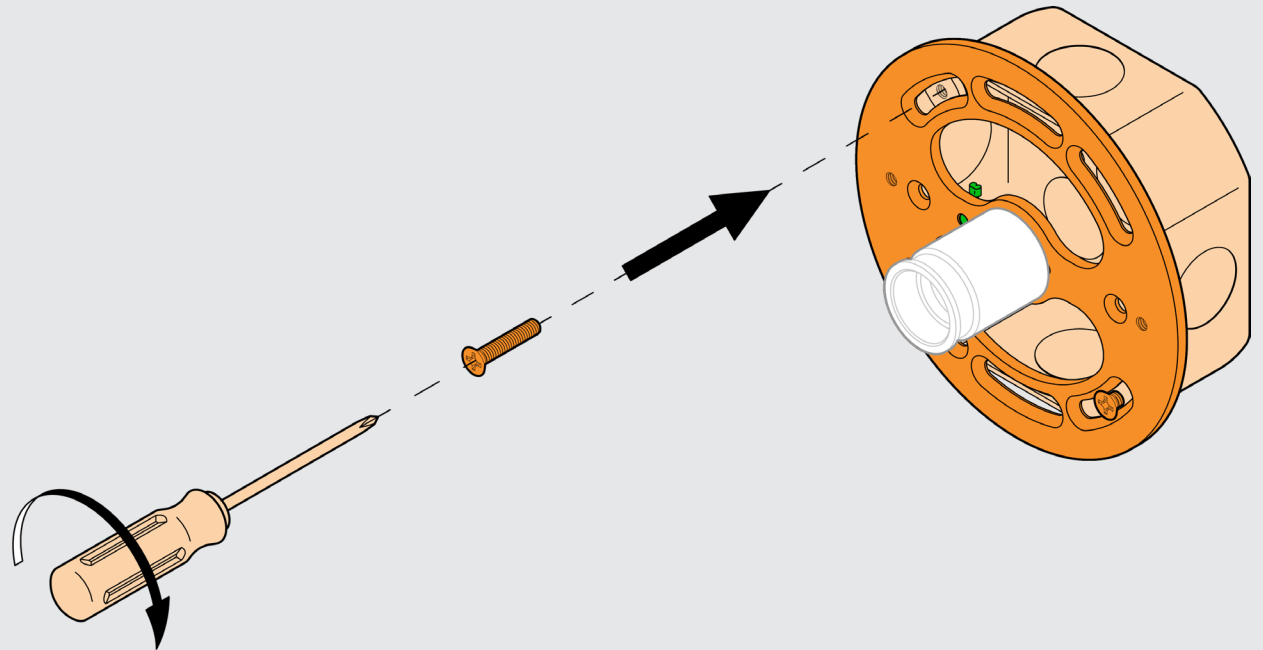

6

Connect the ground wire from the fixture backplate to the ground wire from the junction box. Then, connect the wires from the fixture to the wires from the junction box using wire nuts.

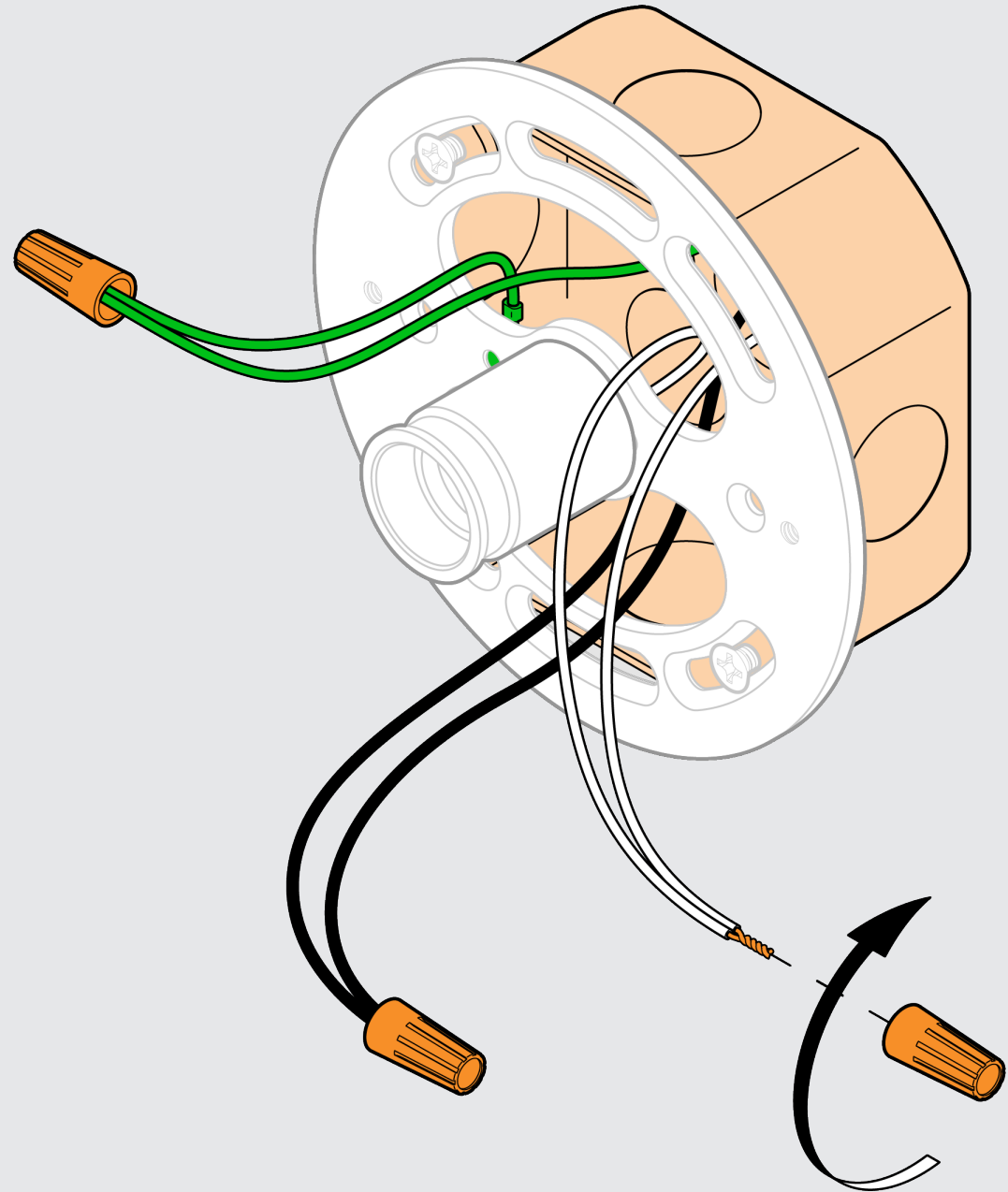

7

Place the wood doughnut back over the socket cover and let it magnetically attach back onto the fixture backplate.

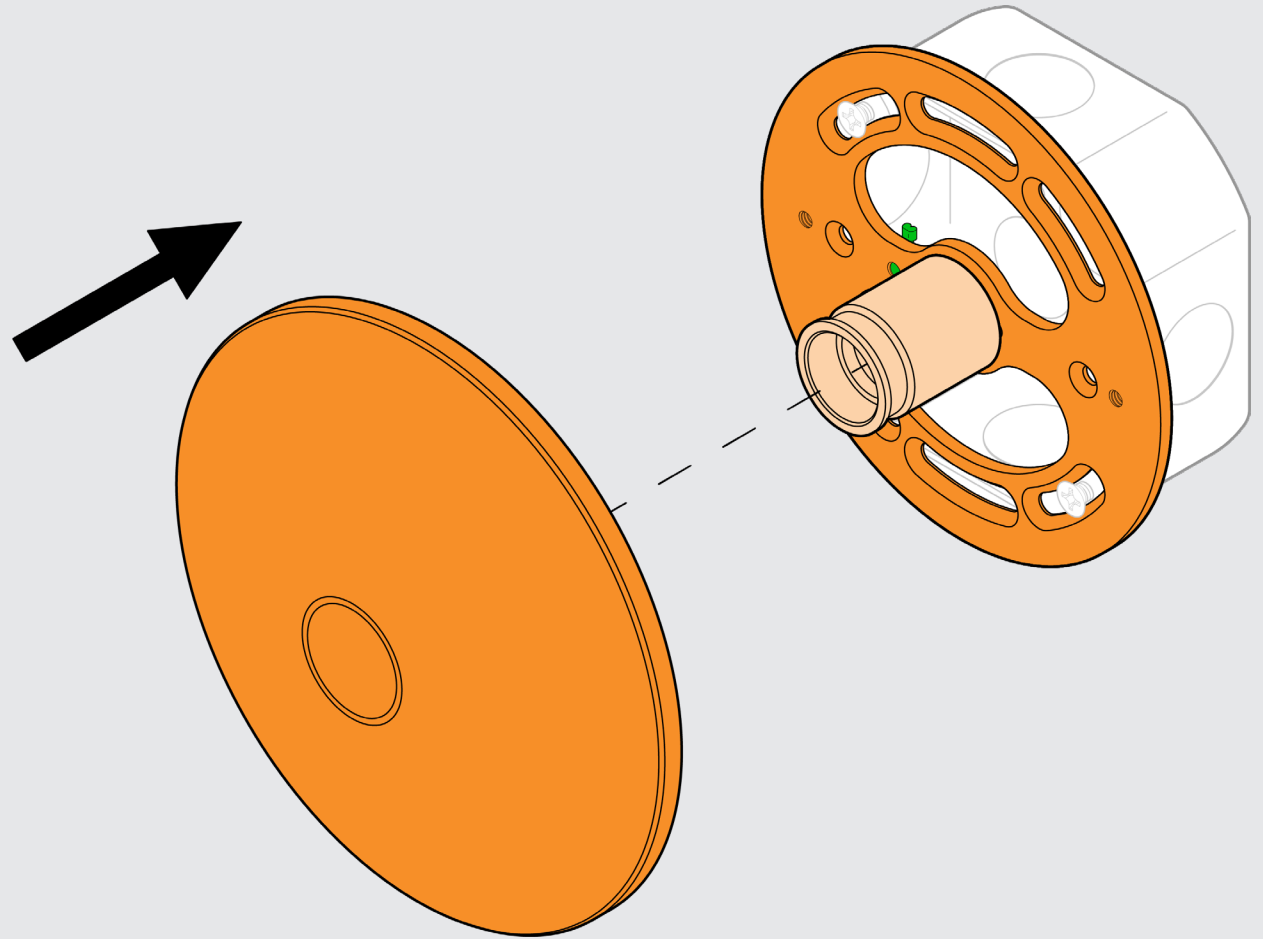

8

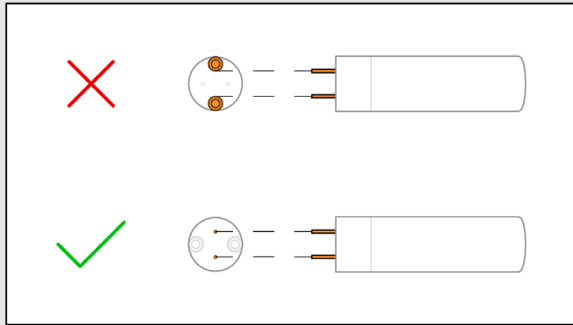

—
Insert the light bulb
into the fixture socket.

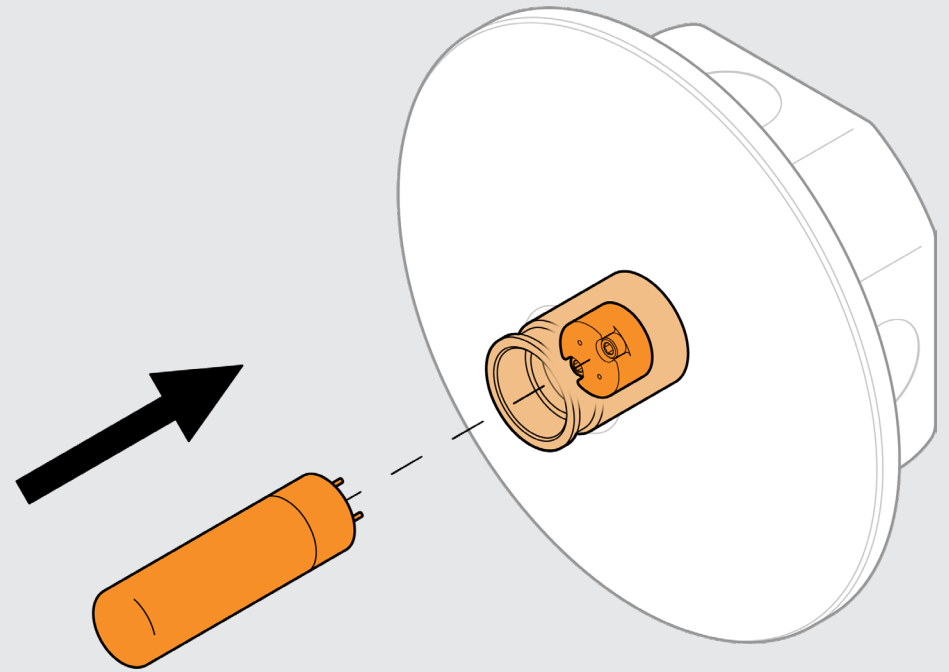

9

Insert the fixture shade over the socket cover and against the wood doughnut and hold in place.

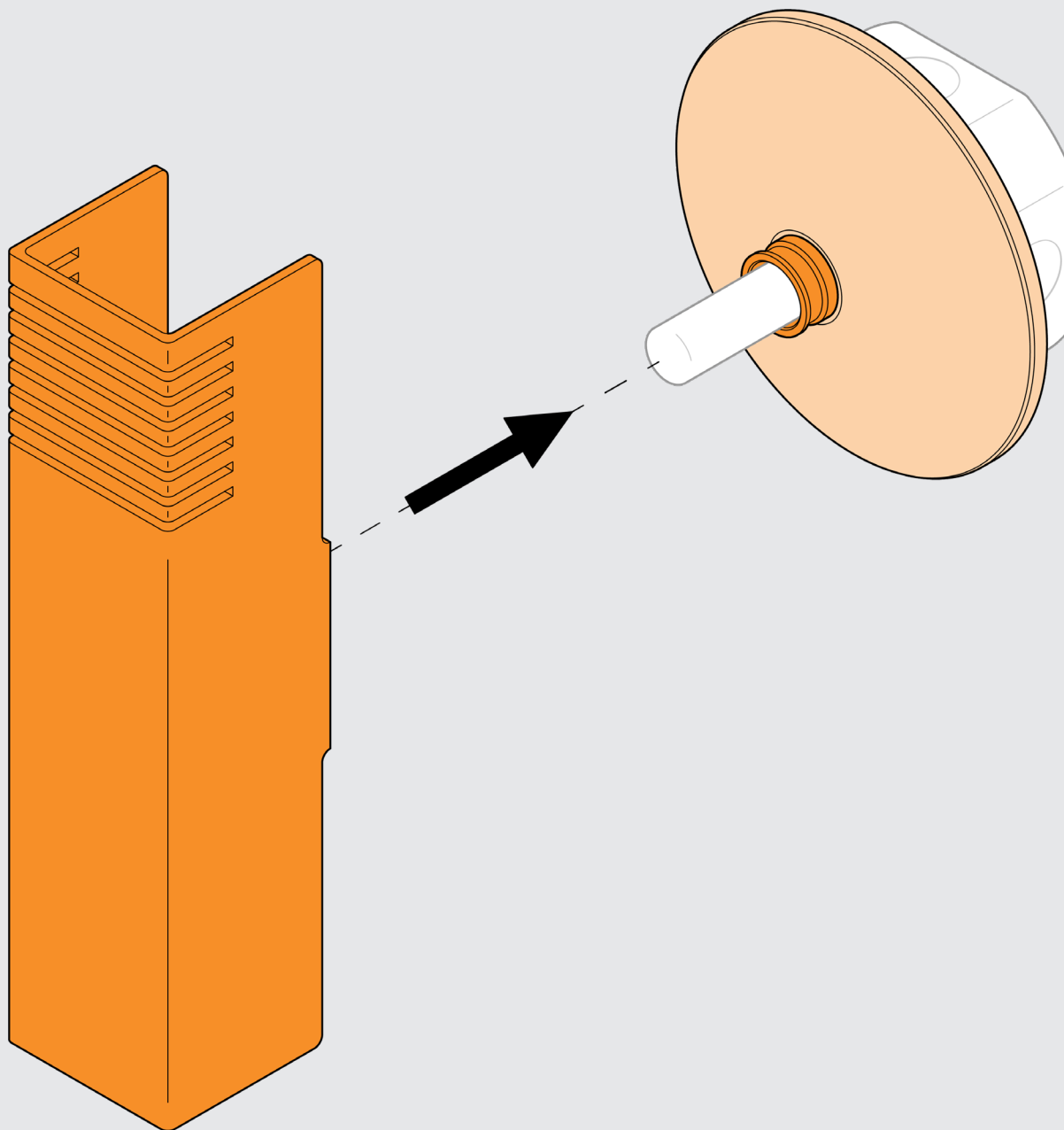

10

Using a hex screwdriver, tighten the two set screws on the shade adapter to secure the fixture shade into place.

